

ULTIMATE PERFORMANCE WHERE IT'S LEAST EXPECTED – IN EVERY DETAIL

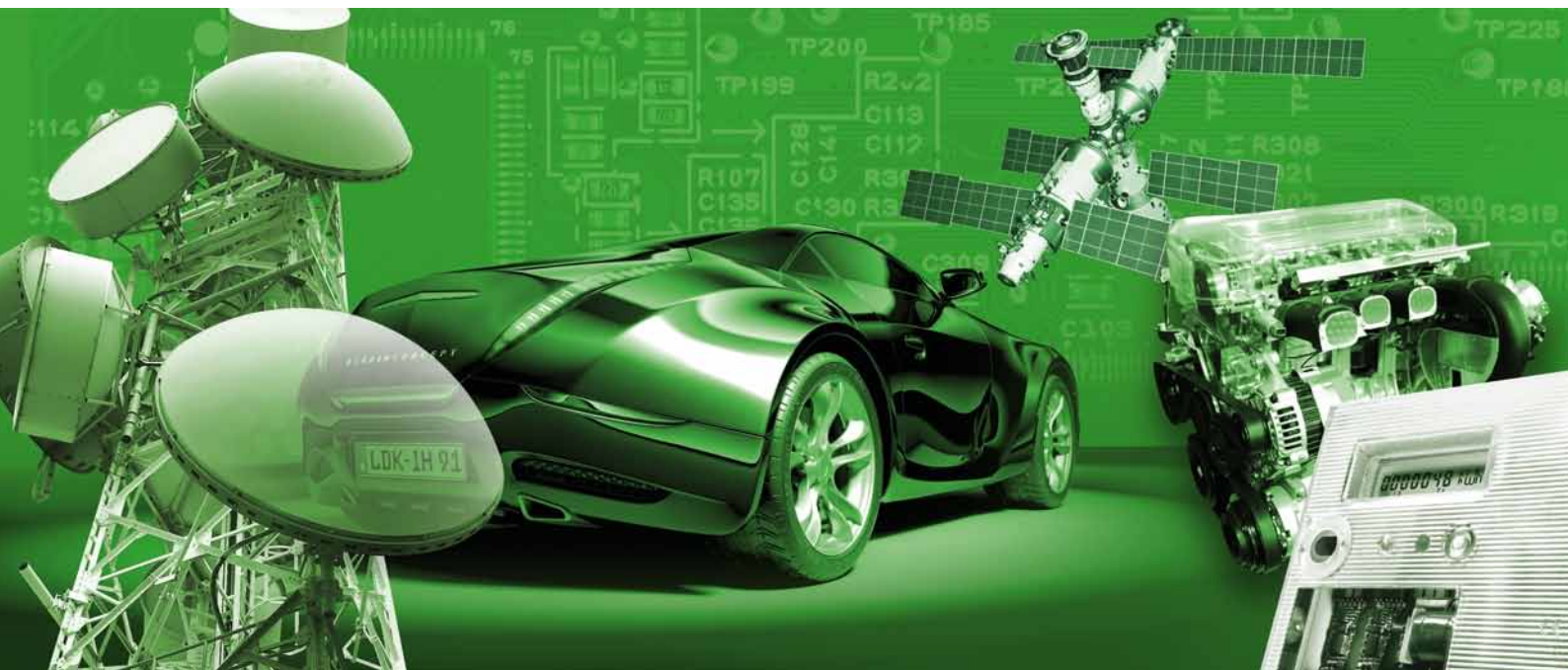

LOW-OHMIC PRECISION AND POWER RESISTORS



ISABELLENHÜTTE

Innovation by Tradition

ISABELLENHÜTTE HEUSLER GMBH & CO. KG

Our company is one of the world's leading manufacturers of electrical resistance and thermoelectric alloys for temperature measurement and a well known manufacturer of passive components for the automotive, electrical and electronics industries. Precision measurement systems from Isabellenhütte set the industry benchmark for current, voltage and temperature measurement in cars and trucks, hybrid and electric vehicles, as well as in industrial and renewable energy generating systems.

As a globally renowned specialist and technology leader, our innovative products consistently redefine the state of the art while showcasing Isabellenhütte's technical and innovative capability. Our success is driven by the continuous development of innovative products, new technologies and sophisticated manufacturing processes. In addition, we concentrate a wide range of production steps and proprietary technologies in-house. Our expertise extends from alloy production and forming through wet chemical processes and assembly to complex automated testing and packaging during final inspection.

Innovation by Tradition

Precision from within // 04

From standard modules to customised solutions – our resistance materials and low-ohmic resistors are developed and manufactured to the highest quality standards.

We're pioneers for a reason and the benchmark // 06

As specialists in current measurement, we're the technology leader across a wide range of sectors // Temperature coefficient, long-term stability, load capacity and inductance are all key factors in our products.

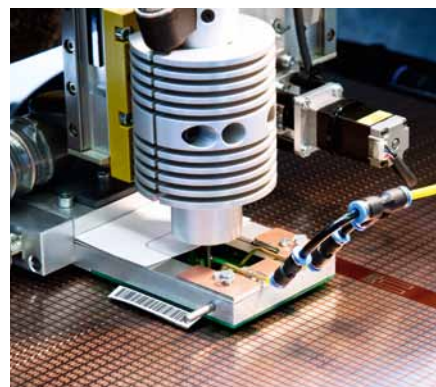

Surface mount assembly

Surface mount assembly // VMx	// 08
Surface mount assembly // VLx	// 09
Surface mount assembly // SMx	// 10
Surface mount assembly // LMx	// 11
Surface mount assembly // SMR/SMV	// 12
Surface mount assembly // BVx	// 13

Bus bar mounting // BAS, BVO, BKW, BVM-F, BVD	// 14
---	-------

Hybrid mounting // PMx, PLU	// 15
-----------------------------	-------

PCB and heat sink mounting // PBH, PBV, PBV-Z, PSB, A-H, AZ-H, RTO-A, RTO-B	// 16
---	-------

Heat sink mounting // RUG-Z, R-Z, IKL (plug-in)	// 18
---	-------

Braking resistors/precharge resistors // BRK, BRO for high loads	// 19
--	-------

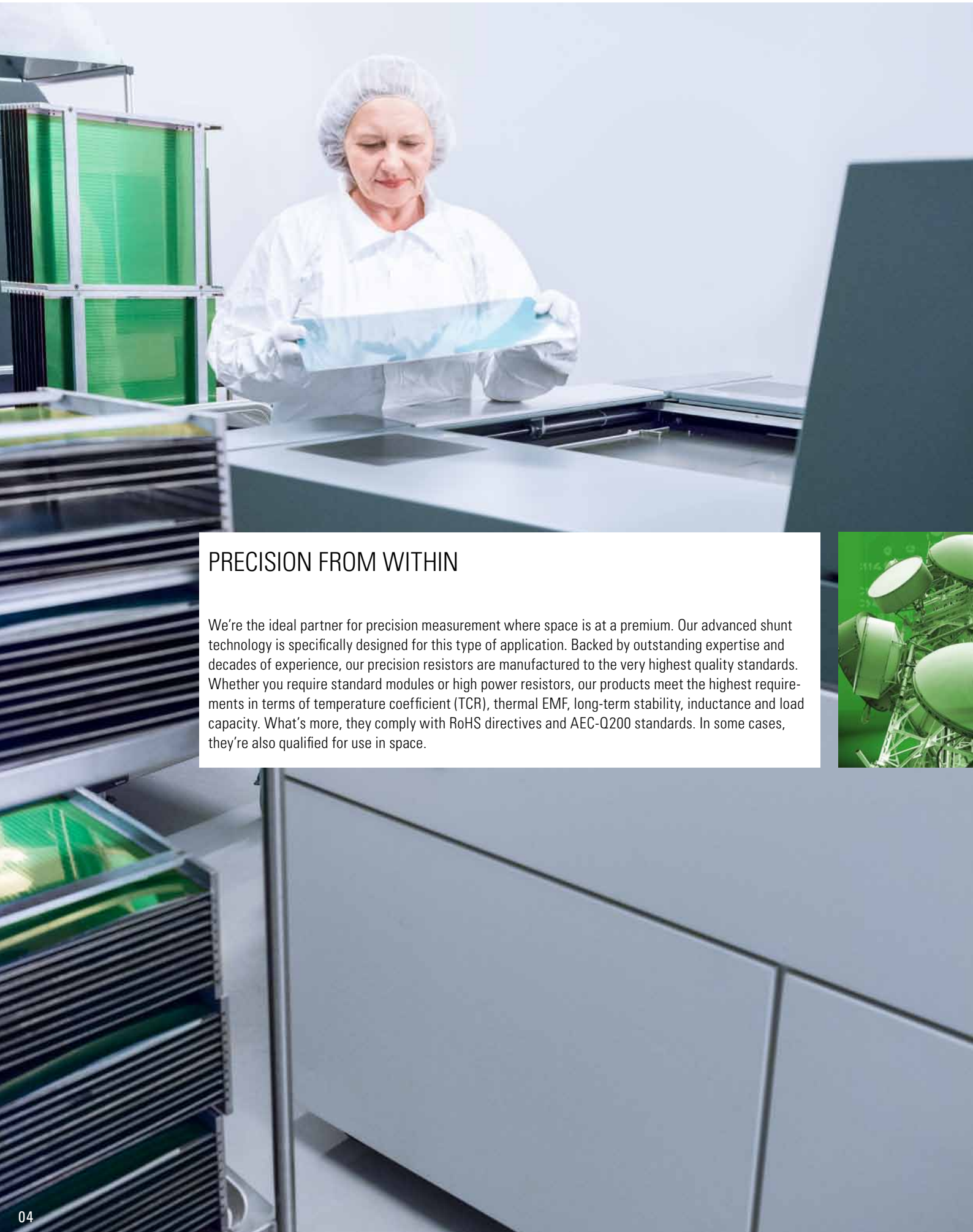

PRECISION FROM WITHIN

We're the ideal partner for precision measurement where space is at a premium. Our advanced shunt technology is specifically designed for this type of application. Backed by outstanding expertise and decades of experience, our precision resistors are manufactured to the very highest quality standards. Whether you require standard modules or high power resistors, our products meet the highest requirements in terms of temperature coefficient (TCR), thermal EMF, long-term stability, inductance and load capacity. What's more, they comply with RoHS directives and AEC-Q200 standards. In some cases, they're also qualified for use in space.



“Our modular design system enables us to create customised solutions for current, voltage and temperature measurement applications in time and affordably.”

THE BASICS OF CURRENT SENSING

When we introduced our ISA-PLAN® and ISA-WELD® technologies, Isabellenhütte set totally new standards for low-ohmic resistors and became the global benchmark in this field. Our physically optimised current sensors (“shunts”) provide a range of unique benefits. In contrast to competing products, ISA-PLAN® and ISA-WELD® retain their specified tolerances under all conditions, i.e. over the entire temperature range, under full power load and throughout the entire operating life cycle.

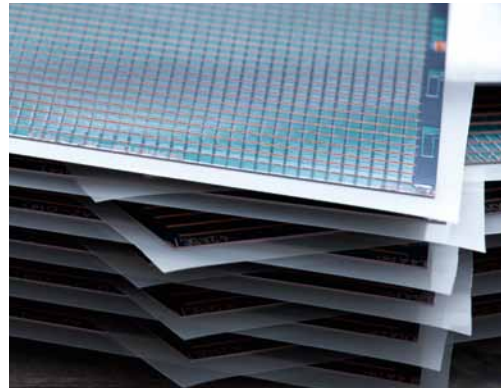

Production panels made from pressed and laminated substrate and resistance material

The following equation generally applies to the voltage measured on a resistor:

$$U = R \cdot I + U_{th} + U_{ind} + U_{iext} + \dots$$

Since the voltage drop in low-ohmic resistors is correspondingly small, error voltages not produced by a current flow can completely distort the measured result. For this reason, it is essential that the product developer and layout designer understand the causes and minimise their influence through careful layout design and, in particular, by selecting appropriate components and materials.

- U_{th} Thermal EMF
- U_{ind} Induced voltage
- U_{iext} Voltage drop on leads

The real resistance value is typically dependent on parameters such as temperature, time, voltage, frequency, etc.

$$R = R(T, t, P, Hz, U, A, \mu, \rho \dots)$$

Some of these characteristics are influenced not only by the choice of material but also by the design of the component and the production process. Isabellenhütte products are physically optimised to ensure the effects described above are reduced as far as possible. Our resistors are made using one of two basic production technologies: ISA-PLAN® (etched-foil resistors) and ISA-WELD® (resistors made from electron-beam welded composites, e.g. Cu-MANGANIN®-Cu).



Components are comprehensively tested, measured and calibrated before packing in standard tapes and reels

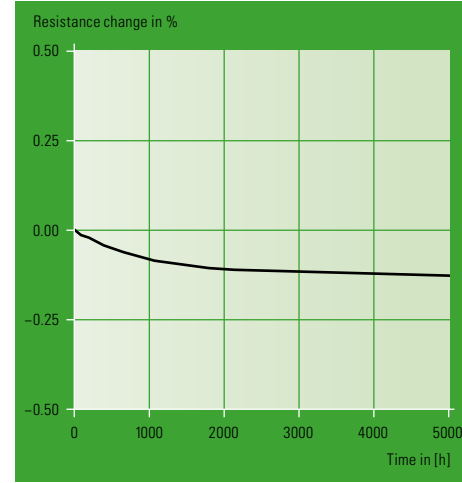

Long-term stability: MANGANIN®

Typical long-term stability at +140°C

WE'RE PIONEERS FOR A GOOD REASON

LONG-TERM STABILITY

Long-term stability is an extremely important characteristic for a sensor. Even after many years of service, it is essential that users can rely on the original calibration. Resistance materials must therefore be stable against corrosion and invulnerable to any metallurgical change in structure or state.

Our MANGANIN®, ZERANIN® and ISAOHM® alloys have a homogeneous mixed crystal structure, which makes them the ideal material for these applications. The alloys are carefully annealed and stabilised and are therefore supplied in their thermodynamic ground state. As a result, they all have resistance stability ratings in the range of ppm per annum. Which is why our alloys have proved themselves for over 100 years in reference resistors worldwide.

TEMPERATURE DEPENDENCE

The temperature dependence of our resistors is mainly determined by the precision resistance alloys MANGANIN®, ZERANIN® and ISAOHM®. In many cases, however, low-ohmic resistors suffer from significant influences of the termination, which is why the sense voltage should be measured via two additional contacts located directly on the resistance material. The examples (right) show that poor layout and/or construction can result in major inaccuracies in both resistance value and temperature coefficients (TCR).

The 10-mm copper leads on a 10-mOhm conventional 2-terminal resistor already create 24 % of the total resistance while increasing the temperature coefficient from 10 ppm/K to almost 1000 ppm/K. The additional resistance on the leads could be offset by calibration, but the effect on the temperature coefficient would still remain the same. It is therefore incorrect to specify the temperature coefficient of the resistance material, a practice that is common on many data sheets.

The second example shows that poor layout design for the sense voltage connection can distort both the resistance value and the temperature coefficient by more than 100 %. In our resistors made from electron-beam welded composites (Cu-MANGANIN®-Cu), the lead resistance is extremely low. The same applies to our SMx, VMx and VLx series, thanks to the copper substrates used in these products. With the right combination of layout, soldering and resistor, it is possible to implement an optimum four-terminal configuration in which the rated resistance and temperature coefficient of the component remains valid in the application.

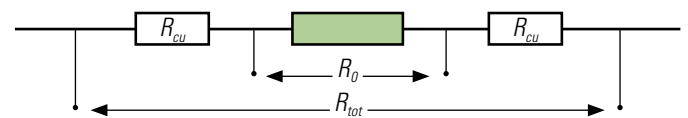

Total resistance	$R_0 + 2 * R_{cu}$
Four-terminal resistor	R_0

Examples:

Cu wire 0.3 mm, 10 mm length	$R_{cu} = 2.4 \text{ mOhm}$
Cu wire 4 mm*0.2 mm*35 µm	$R_{cu} = 10 \text{ mOhm}$

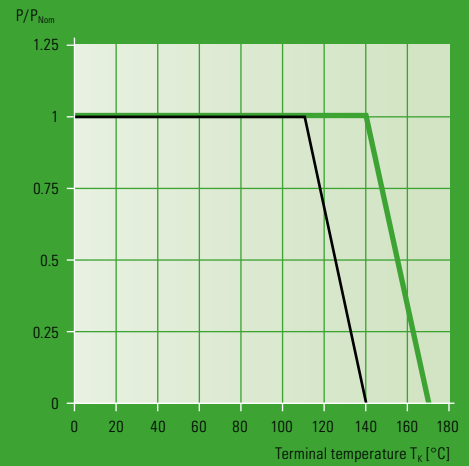
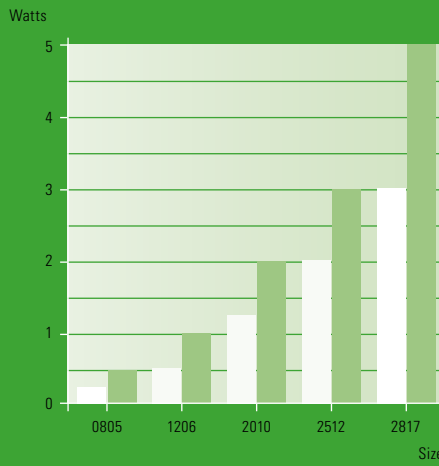
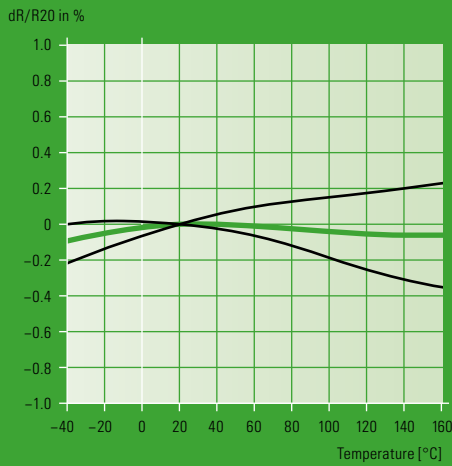

Temperature dependence: ZERANIN®

- Upper/lower limit
- Typical temperature dependence of a resistor

Comparison with strongest competitor

- Benefit: higher load capacity on small area
- Competitor
 - Isabellenhütte

Power derating curve (0.5 mOhm)

- Stability 1.0%
- Stability 0.5%

HIGH LOAD CAPACITY

Due to the fact that the thermal conductivity of resistance materials is relatively low compared with copper and the resistor foil thickness is low, in the region of 20 to 150 μm, it is not possible to conduct the heat out of the resistor via the resistance material into the terminals.

For this reason, the resistance foil on our ISA-PLAN® resistors is bonded to a metal substrate with good thermal conductivity (copper or aluminium) using a thin adhesive that is also thermally conductive. This enables effective discharge of dissipated heat via the substrate and terminals. The result is a relatively very low internal heat resistance, typically in the region of 10 to 30 K/W.

Our resistors can therefore be used at their full rated power up to a very high terminal temperature, i.e. the derating point on the power derating curve is very high compared with other products. At the same time, the maximum temperature in the resistance material is kept low, thereby significantly improving long-term stability under load and the TCR-dependent reversible resistance change.

LOWER INDUCTANCE

Since in many applications it is necessary to not only measure but also control switch-mode currents, the inductance of the shunt or measurement circuit is of great importance.

To reduce inductance, our SMD resistors have a flat design, with or without closely adjacent meanders. Performance is further improved by the diamagnetic characteristics of all our precision alloys mentioned above, as well as the metal substrate and four-terminal connection.

However, since the sensing leads and the resistor form an antenna structure in which voltages are induced by the magnetic field generated by the current flow as well as other external magnetic fields, it is especially important to ensure that the area enclosed by the leads is as small as possible. We therefore recommend the use of closely adjacent leads or even a strip-line arrangement, i.e. where the two lines are routed to the amplifier on two separate layers congruently one above the other.



SURFACE MOUNT ASSEMBLY (ISA-PLAN®)

Product series: VMx

Sizes: 0805 / 1206 / 2010 / 2512

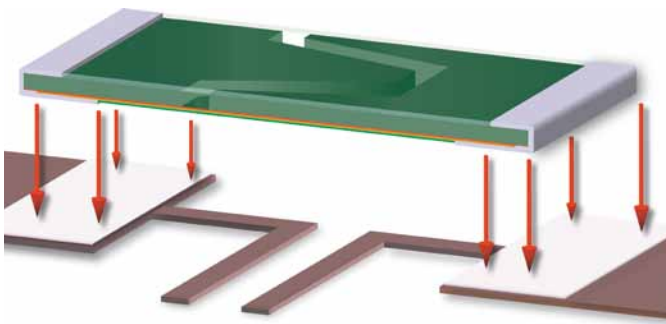

Technical data

Resistance values	5 mOhm to 1 Ohm
Tolerance	1 %, 5 %
Temperature coefficient	< 20 ppm/K (+20 °C to +60 °C)
Applicable temperature range	-65 °C to +170 °C
Power rating	Up to 3 W
Internal heat resistance	< 25 K/W
Insulation voltage	200 V
Inductance	< 2 nH
Stability (nominal load) deviation	< 0.5 % after 2000 h ($T_K = 65 °C$)
T_K = Terminal temperature	< 0.7 % after 2000 h ($T_K = 95 °C$)

Features

- _ Up to 3 Watts permanent power at 95 °C
- _ Very high pulse power rating
- _ Very good long-term stability
- _ Standard solder pad size
- _ Mounting: reflow and infrared soldering
- _ AEC-Q200 qualified

Advantages/user benefits

- _ 4-terminal connection on substrate
- _ Tin/copper plated terminals for optimum soldering points
- _ Standard solder pads
- _ Extremely low internal heat resistance
- _ Virtually unaffected by ambient temperature in range -65 to +170 °C due to low TCR
- _ Negligible thermal EMF against copper (< 1 µV/K)
- _ Very good long-term stability under full load

Packaging	VMI	VMK	VMP	VMS
Sizes	0805	1206	2010	2512
Parts per reel	15000	12500	12500	9000
In plastic or cardboard tape	8 mm	8 mm	12 mm	12 mm



SURFACE MOUNT ASSEMBLY (ISA-PLAN®)

Product series: VLx

Sizes: 0612/1020

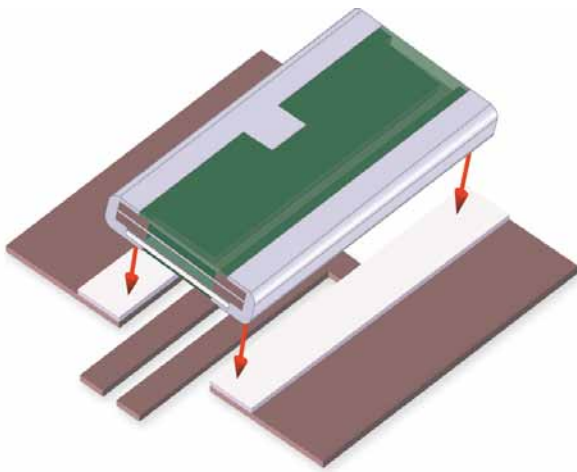

Technical data

Resistance values	1 to 39 mΩ
Tolerance	1 %, 5 %
Temperature coefficient	< 50 ppm/K (+20 °C to +60 °C)
Applicable temperature range	-65 °C to +170 °C
Power rating	Up to 2 W
Internal heat resistance	< 20 K/W
Insulation voltage	200 V
Inductance	< 1 nH
Stability (nominal load) deviation	< 0.5 % after 2000 h ($T_K = 100\text{ °C}$)
T_K = Terminal temperature	< 0.7 % after 2000 h ($T_K = 130\text{ °C}$)

Features

- _ Up to 2 Watts permanent power at 130 °C
- _ Small component size (0612)
- _ Very high pulse power rating
- _ Very good long-term stability
- _ Mounting: reflow and infrared soldering
- _ AEC-Q200 qualified

Advantages/user benefits

- _ 4-terminal connection on substrate
- _ Tin/copper plated terminals for optimum soldering points
- _ Reflow and infrared soldering
- _ Extremely low internal heat resistance
- _ Virtually unaffected by ambient temperature in range -55 to +170 °C due to low TCR
- _ Negligible thermal EMF against copper (< 1 pV/K)
- _ Very good long-term stability under full load
- _ Large soldering and terminal surface
- _ High mechanical strength of solder joint

Packaging	VLK	VLP
Sizes	0612	1020
Parts per reel	10000	10000
In plastic or cardboard tape	8 mm	12 mm



SURFACE MOUNT ASSEMBLY (ISA-PLAN®)

Product series: SMx

Sizes: 1206/2010/2512/2817

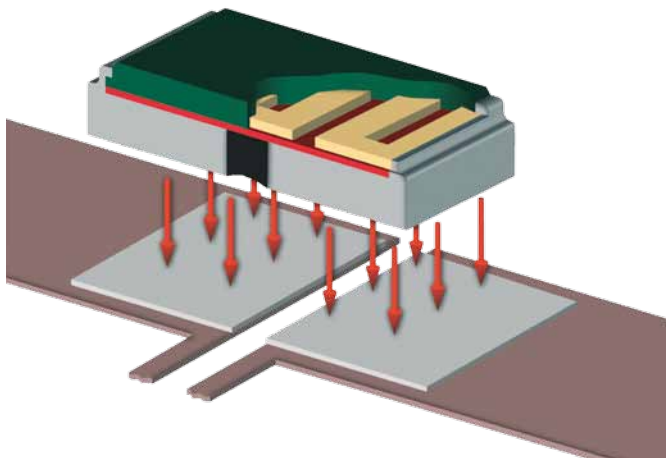

Features

- _ Up to 5 Watts permanent power at 105 °C
- _ Very high pulse power rating
- _ Very good long-term stability
- _ Mounting: reflow- and infrared soldering
- _ AEC-Q200 qualified

Technical data

Resistance values	3 mOhm to 4 Ohm
Tolerance	0.5 %, 1 %, 5 %
Temperature coefficient	< 50 ppm/K (+20 °C to +60 °C)
Applicable temperature range	-55 °C to +170 °C
Power rating	Up to 5 W
Internal heat resistance	From 13 K/W
Insulation voltage	200 V
Inductance	< 3 nH
Stability (nominal load) deviation	< 0.5 % after 2000 h ($T_K = 75 °C$)
T_K = Terminal temperature	< 1.0 % after 2000 h ($T_K = 105 °C$)

Advantages/user benefits

- _ 4-terminal connection on substrate
- _ Extremely low internal heat resistance
- _ Virtually unaffected by ambient temperature in range -55 to +170 °C due to low TCR
- _ Very good long-term stability under full load
- _ High pulse load capacity

Packaging	SMK	SMP	SMS	SMT
Sizes	1206	2010	2512	2817
Parts per reel	12500	10000	5000	5000
In plastic tape	8 mm	12 mm	12 mm	12 mm



SURFACE MOUNT ASSEMBLY (ISA-PLAN®)

Product series: LMx

Sizes: 2010/2512

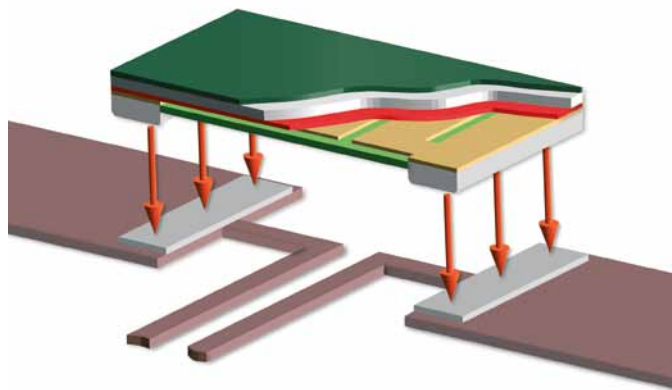

Technical data

Resistance values	10 mOhm to 330 mOhm
Tolerance	1 %, 5 %
Temperature coefficient	< 50 ppm/K (+20 °C to +60 °C)
Applicable temperature range	-55 °C to +170 °C
Power rating	Up to 3 W
Internal heat resistance	< 25 K/W
Insulation voltage	100 V
Inductance	< 3 nH
Stability (nominal load) deviation	< 1 % after 2000 h ($T_k = 70\text{ °C}$)
T_k = Terminal temperature	< 2 % after 2000 h ($T_k = 95\text{ °C}$)

Features

- _ Up to 3 Watts permanent power at 95 °C
- _ Very high pulse power rating
- _ Very good long-term stability
- _ Standard solder pad size
- _ Mounting: reflow and infrared soldering

Advantages/user benefits

- _ Low-ohmic precision resistors for standard applications
- _ Low internal heat resistance
- _ High pulse power rating and high permanent power
- _ Flip-chip mounting

Packaging	LMP	LMS
Sizes	2010	2512
Parts per reel	10000	5000
In plastic or cardboard tape	12 mm	12 mm



SURFACE MOUNT ASSEMBLY (ISA-PLAN®)

Product series: SMR/SMV

Sizes: 4723

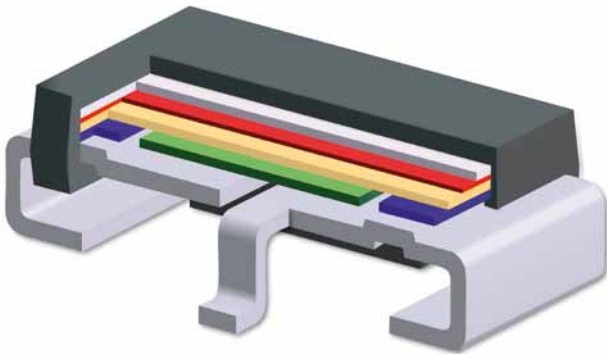

Features

- _ 5 Watts permanent power at 65 °C
- _ Standard solder pad size
- _ High pulse load capacity
- _ Reflow, infrared and wave soldering
- _ Epoxy thermoset encapsulation

Technical data

Resistance values	1 mOhm to 4.7 Ohm
Tolerance	0.5 %, 1 %, 5 %
Temperature coefficient	< 30 ppm/K (+20 °C to +60 °C)
Applicable temperature range	-55 °C to +140 °C
Power rating	5 W
Internal heat resistance	< 15 K/W
Insulation voltage	1000 V
Inductance	< 10 nH
Stability (nominal load) deviation	< 0.5 % after 2000 h ($T_K = 65 °C$)
T_K = Terminal temperature	

Advantages/user benefits

- _ 4-terminal connection (SMV)
- _ Heavy high-capacity copper terminals
- _ High pulse load capacity

Packaging	SMR	SMV
Parts per reel	1500	1500
In plastic tape	24 mm	24 mm



SURFACE MOUNT ASSEMBLY (ISA-WELD®)

SMD resistors for high current applications

Product series: BVx

Sizes: 1216 / 2512 / 2725 / 3812 / 3920 / 4026 / 5930

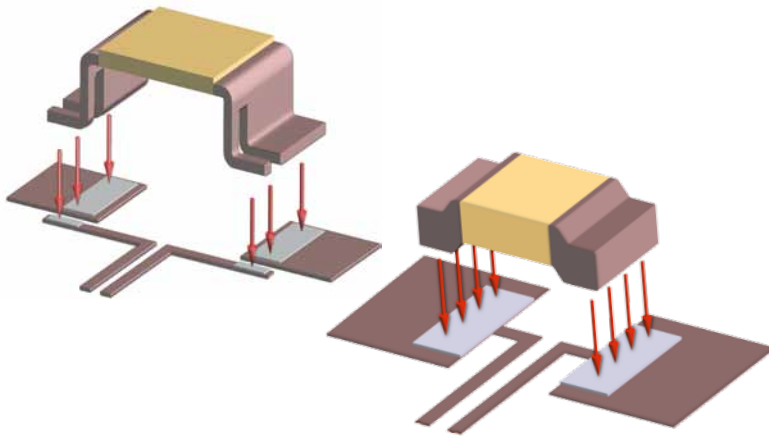

Features

- _ Up to 12 Watts permanent power
- _ Ultra-low resistance values
- _ Ideal for mounting on DCB/IMS substrate
- _ Standard solder pad size
- _ Made from electron-beam welded composite material

Technical data

Resistance values	0.2 to 10 mOhm
Tolerance	1 %, 5 %
Temperature coefficient	From 20 ppm/K (+20 °C to +60 °C)
Applicable temperature range	-55 °C to +170 °C
Power rating	Up to 12 W
Internal heat resistance	From 3 K/W
Insulation voltage	100 V
Inductance	< 10 nH
Stability (nominal load) deviation	< 0.5 % after 2000 h ($T_K = 90\text{ °C}$)
T_K = Terminal temperature	< 1 % after 2000 h ($T_K = 120\text{ °C}$)

Advantages/user benefits

- _ 4-terminal connection (BVR, BVB, BVN)
- _ Suitable for soldering temperatures up to 350 °C/30 secs
- _ High load capacity
- _ Very good long-term stability

Packaging	BVN	BVT	BVB	BRS	BVS	BVR	BVE
Sizes	1216	2512	2725	3812	3920	4026	5930
Parts per reel	3000	5000	1400	2500	3000	1400	2000
In plastic tape	12 mm	12 mm	16 mm	16 mm	16 mm	24 mm	24 mm



BUS BAR MOUNTING

Bus bar components in composite material for high current applications

Product types: *BAS/BVO/BKW/BVM-F/BVD*

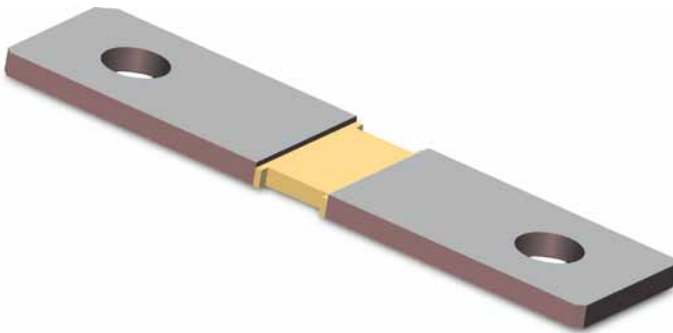

Features

- _ 15 Watts permanent power
- _ Low resistance current sensors
- _ Bus bar mounting
- _ Made from electron-beam welded composite material

Technical data

Resistance values	<i>0.1 to 1 mOhm</i>
Tolerance	<i>5 %</i>
Temperature coefficient	<i>From 30 ppm/K (+20 °C to +60 °C)</i>
Applicable temperature range	<i>-55 °C to +170 °C</i>
Power rating	<i>Up to 15 W</i>
Continuous current	<i>Up to 350 A</i>
Pulse energy	<i>200 J</i>
Internal heat resistance	<i>< 0.2 K/W</i>
Inductance	<i>From 1 nH</i>
Stability (nominal load) deviation	<i>< 0.5 % after 2000 h (T_k = 105 °C)</i>
T _k = Terminal temperature	<i>< 1 % after 2000 h (T_k = 140 °C)</i>

Advantages/user benefits

- _ 4-terminal connection (BVO)
- _ Suitable for soldering temperatures up to 350 °C/30 secs or 250 °C/10 mins
- _ High permanent and pulse power rating
- _ Very good long-term stability
- _ Solderable and weldable

Packaging	BAS	BVO	BKW	BVM-F	BVD
Parts	100	500	500	1000	500
Bulk goods in plastic bags					



HYBRID MOUNTING

Bondable resistors for high power applications

Product series: PMx/PLU

Sizes: 2439 / 2512 / 3925 / 3939

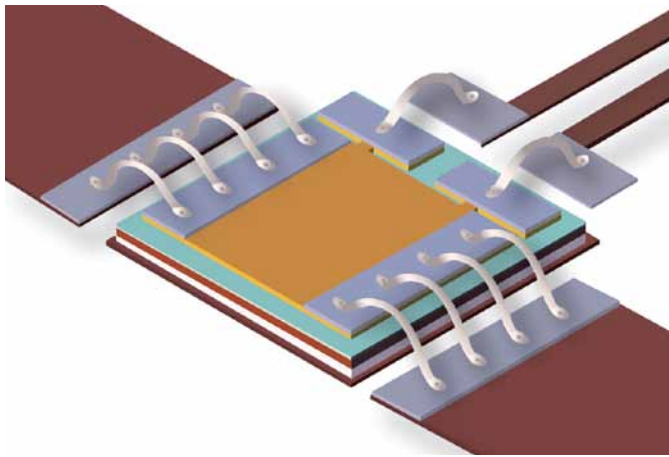

Technical data

Resistance values	1 to 200 mOhm
Tolerance	0.5 %, 1 %, 2 %, 5 %
Temperature coefficient	< 30 ppm/K (+20 °C to +60 °C)
Applicable temperature range	-55 °C to +170 °C
Power rating	Up to 20 W
Internal heat resistance	From 2.5 K/W
Insulation voltage	100 V
Inductance	< 10 nH
Stability (nominal load) deviation	< 0.5 % after 2000 h ($T_K = 90\text{ °C}$)
T_K = Terminal temperature	< 1 % after 2000 h ($T_K = 120\text{ °C}$)

Features

- _ Up to 20 Watts permanent power
- _ Very good heat dissipation
- _ Flip-chip mounting
- _ Reflow and infrared soldering

Advantages/user benefits

- _ 4-terminal connection
- _ Direct DBC/IMS solder mounting
- _ Ni-plated/Au-plated bond pads
- _ High load capacity
- _ Bondable resistor
- _ Mounting: reflow soldering and bonding on substrate

Packaging	PLU	PMH	PMU	PMB
Sizes	2439	2512	3925	3939
Parts per reel	3000	5000	3000	3000
In plastic tape	16 mm	12 mm	16 mm	16 mm



PCB AND HEAT SINK MOUNTING

Product types: PBH/PBV/PBV-Z/PSB/A-H/AZ-H

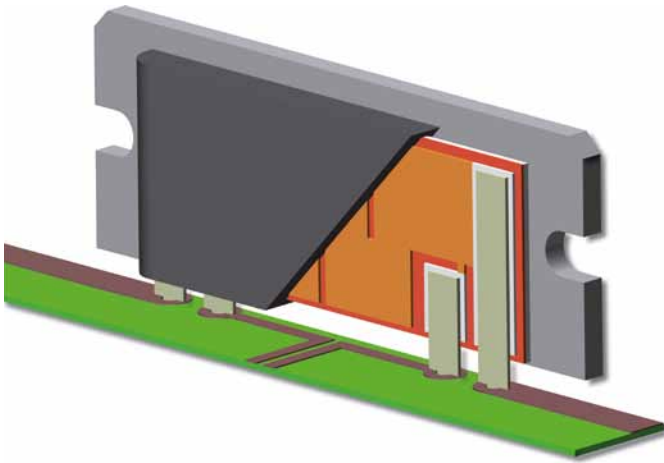

Features

- _ Up to 10 Watts permanent power
- _ Ultra-low resistance values
- _ Very high pulse power rating
- _ Very good long-term stability
- _ Low self-heating

Technical data

Resistance values	0.5 mOhm to 100 Ohm
Tolerance	0.1 %, 0.5 %, 1 %, 5 %
Temperature coefficient	From 3 ppm/K (+20 °C to +60 °C)
Applicable temperature range	-55 °C to +140 °C
Power rating	Up to 10 W
Internal heat resistance	From 3 K/W
Insulation voltage	< 500 V
Inductance	From 10 nH
Stability (nominal load) deviation	< 0.1 % after 2000 h ($T_K = 80\text{ °C}$)
T_K = Terminal temperature	with heat sink

Advantages/user benefits

- _ 4-terminal connection (A-H, PBV)
- _ Suitable for soldering temperatures up to 350 °C/30 secs
- _ Heat sink mounting possible
- _ Available from TCR3 (AZ-H)

Packaging	PBH	PBV	PBV-Z	PSB	A-H	AZ-H
In plastic tubes	35	25	25	44		
On ESD pallets					40 / 50	40 / 50



PCB AND HEAT SINK MOUNTING

Product types: RTO-A/ RTO-B

Sizes: SOT 227B (ISOTOP)

Features

- _ Up to 40 Watts permanent power
- _ Cable or bus bar connection
- _ Optimised heat dissipation
- _ Very high pulse power rating up to 20 J

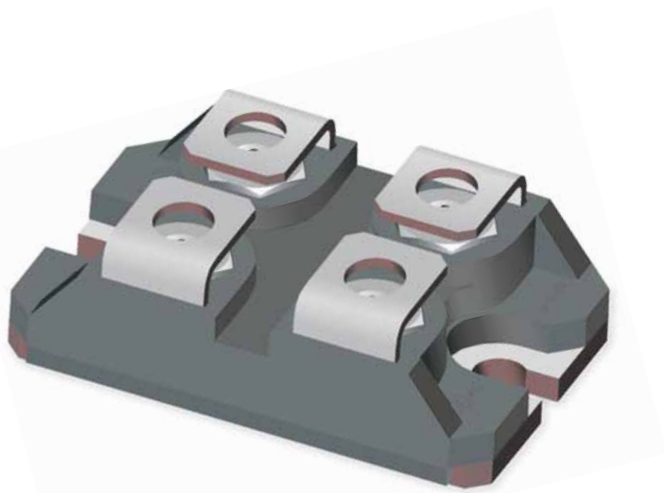

Technical data

Resistance values	1 mOhm to 50 Ohm
Tolerance	1 %, 5 %
Temperature coefficient	< 50 ppm/K (+20 °C to +60 °C)
Applicable temperature range	-55 °C to +170 °C
Power rating	Up to 40 W
Internal heat resistance	< 2.5 K/W
Insulation voltage	2500 V DC
Inductance	From 5 nH
Stability (nominal load) deviation	< 0.5 % after 2000 h ($T_K = 40\text{ °C}$)
T_K = base plate	< 1 % after 2000 h ($T_K = 70\text{ °C}$)

Advantages/user benefits

- _ 2-terminal connection (RTO-A),
4-terminal connection (RTO-B)
- _ Dielectric withstanding voltage 2500 V DC

Packaging	RTO-A	RTO-B
On ESD pallets	50	50



HEAT SINK MOUNTING

High precision calibration resistors for laboratory applications

Product types: RUG-Z/R-Z/IKL (plug-in)

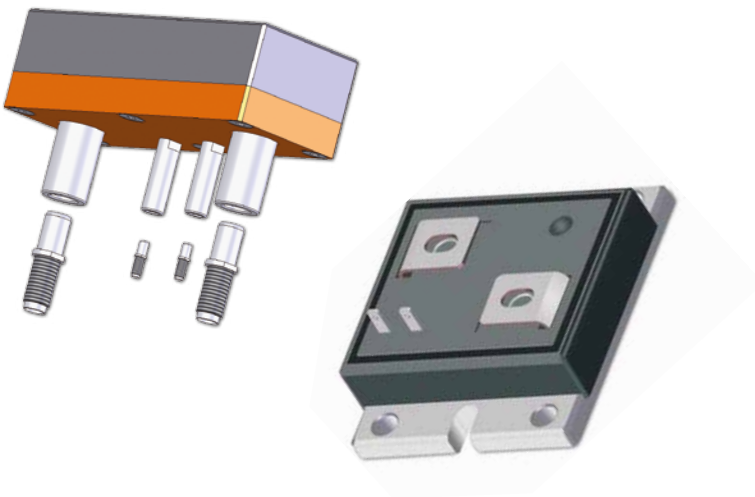

Features

- _ Up to 500 Watts permanent power (R-Z)
- _ Constant current up to 700 A (R-Z)
- _ For highest currents and precision
- _ Very high pulse power rating up to 200 J
- _ Extremely low TCR
- _ Calibration and reference resistor

Technical data

Resistance values	0.03 mOhm to 100 Ohm
Tolerance	0.01 %, 0.1 %, 0.5 %, 1 %
Temperature coefficient	From 1 ppm/K (+20 °C to +60 °C)
Applicable temperature range	-55 °C to +85 °C
Power rating	Up to 500 W
Internal heat resistance	< 0.02 K/W
Insulation voltage	500 V AC
Inductance	< 3 nH
Stability (nominal load) deviation	< 0.1 % after 2000 h ($T_K = 75 °C$)
T_K = Terminal temperature	(R-Z)

Advantages/user benefits

- _ 4-terminal connection
- _ Dielectric withstanding voltage 500 V AC
- _ Optimised heat dissipation
- _ DKD calibration possible

Packaging

RUG-Z

Singly

R-Z

Singly

IKL

Singly



BRAKING RESISTORS/PRECHARGE RESISTORS

Product types: **BRK/BRQ for high loads**

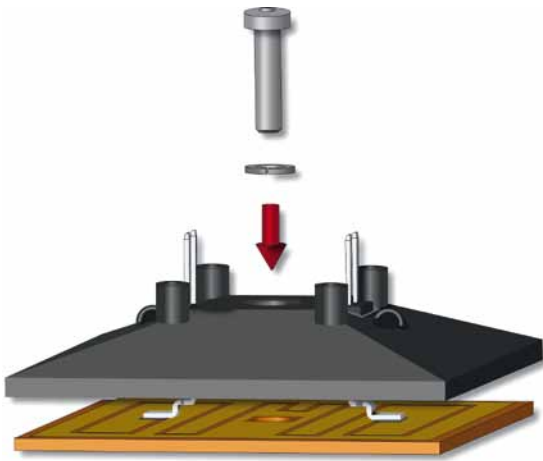

Features

- _ Up to 300 Watts permanent power
- _ Up to 3 kW pulse power for 1 sec
- _ Solid, copper substrate as heat sink for pulse power
- _ Flying leads and pin connectors available
- _ Protection type IP 54

Technical data

Resistance values	1 to 400 Ohm
Tolerance	10%
Applicable temperature range	-50 °C to +150 °C
Load capacity	Up to 300 W
Internal heat resistance	< 0.05 K/W
Insulation voltage	750 VAC/1000 VDC
Stability (nominal load) deviation	< 1% after 1000 h
Cu-substrate	(Cu-substrate = +130 °C)

Advantages/user benefits

- _ Easy mounting
- _ Compact size
- _ Very good thermal conductivity
- _ High pulse load capacity
- _ UL-listed materials

Packaging	BRK	BRQ
	Singly	Singly

-  **INDUSTRIAL**
-  Drive technology
-  Frequency converters
-  Digital energy meters
-  Uninterruptible power supply
-  Solar
-  Wind
-  Power modules
-  **AUTOMOTIVE (AEC-Q200 QUALIFIED)**
-  Diesel and petrol direct injection systems
-  Electric power steering
-  Vehicle lighting systems
-  Climate control
-  Electric parking brake systems
-  **HYBRID AND ELECTRIC VEHICLES**
-  Batteries
-  Fuel cells
-  Electric vehicles
-  **COMPUTERS**
-  **MEDICAL ENGINEERING**
-  **ELECTRICAL ENGINEERING**
-  **DOMESTIC APPLIANCES**
-  **MEASUREMENT SYSTEMS**
-  **LABORATORY**
-  **AEROSPACE**

ORDERING CODES

ISA-PLAN®

ISA-WELD®

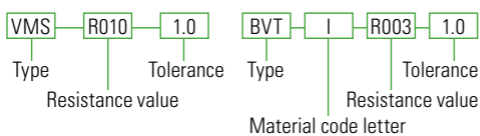

ISA-PLAN®

is a special manufacturing process in which resistance elements are etched from the precision resistance alloys MANGANIN® and ZERANIN® and then electrically insulated and mounted on a metal substrate with good heat-conducting properties. The planar structure and optimised current-density distribution enable low temperature coefficients (TCR), low-inductance designs, very low internal heat resistance and therefore a high load capacity.

ISA-WELD®

is a patented process for the manufacture of advanced high-performance resistors. The resistors are made from solid electron-beam welded composite materials incorporating one of our resistance alloys, e.g. MANGANIN®, ZERANIN® or ISAOHM®. They can be stamped or bent to suit almost any shape or application. ISA-WELD® resistors are used in high-current applications in the automotive industry, battery charging technology, drive technology and electronic energy meters.

MANGANIN®

is a resistance alloy developed by Isabellenhütte which is made from copper, manganese and nickel. MANGANIN® has been used in precision resistors worldwide for over 100 years; it has a moderate specific resistivity, a very low temperature coefficient (TCR) and a low thermal EMF against copper.

ZERANIN®

was developed as a low-ohmic alternative to MANGANIN®. This copper-manganese-tin alloy has an even better temperature coefficient (TCR) but slightly lower specific resistivity. It is therefore ideal for very low-ohmic resistors with extremely high precision characteristics.

ISAOHM®

is another resistance alloy developed by Isabellenhütte, this time made from nickel and chrome with traces of aluminium, silicon, manganese and iron. ISAOHM® is a very versatile material thanks to its particularly high specific resistivity, low temperature coefficient (TCR) and low thermal EMF against copper. It is mainly used in wire form for the production of high-ohmic, ultra-stable resistors and potentiometers as used in the automotive and consumer electronics industries as well as testing and automatic control equipment.

CONTACT

.....
sales.components@isabellenhuette.de
.....

PROVIDED BY



ISABELLENHÜTTE

Innovation by Tradition

Isabellenhütte Heusler GmbH & Co. KG
Eibacher Weg 3-5 · 35683 Dillenburg · Germany
P.O. Box 1453 · 35664 Dillenburg · Germany
Tel +49 (0)2771 934-0 · Fax +49 (0)2771 23030
info@isabellenhuette.de · www.isabellenhuette.de